

**KEE HING CHEUNG KEE CO., LTD.  
DLFTZ CHANG HING KEE  
INT'L INDUSTRY & TRADE CO., LTD.**



**Basic Hospital Products**

# Index

## **Basic Surgical -----P2-8**

Surgical thread-----P2-4

Needle-----P4

Blade &Knife-----P4-5

Scissors-----P6

Forceps-----P7-8

## **Basic Diagnosis -----P9-23**

Stethoscope-----P9-11

Sphygmomanometer-----P11-14

Thermometer-----P15-16

NET endoscope-----P16-18

Examine light-----P19-20

Facial features inspector-----P21-23

Eye sight box-----P23

Tongue depressor-----P23

## **Infusion -----P24-27**

Disposable syringe-----P24

Insulin syringe-----P24

Auto destroy syringe-----P24

Infusion set-----P25

Blood transfusion-----P25

Scalp vein needle-----P25

Infusion pump-----P26-27

## **Orthopedics-----P27-34**

First aid bandage-----P27

Aloe wound protection bandage-----P28

Hydrogel Dressing-----P28

Swab-----P29

Vaseline

gauze-----P30

Gauze ball-----P30

Gauze bandage-----P31

Triangular bandage-----P32

Plaster bandage-----P32

Adhesive bandage/tape/plaster-----P32-34

## **First Aid -----P35-43**

First aid kit-----P35-39

Foldaway stretcher-----P40-41

Oxygen mask-----P42-43

## **Doctors' protective-----P43-49**

Surgical gown-----P43

Surgical drape-----P44

Protective

gown-----P44

Sleeves-----P45

Bed sheet/pillow case-----P45

Apron-----P45

Gloves-----P46-47

Mask-----P47-48

Shoes cover-----P48

Cap-----P48-49

## **For old people -----P50-64**

Oxygen concentrator-----P50-51

Anti-decubitus-----P51-52

Inflatable hair wash basin-----P52

Portable phlegm suction unit-----P52-53

Medicine timer box-----P53-56

Toilet raiser-----P56-57

Hearing aid-----P57-61

Cervical vertebra traction device-----P62

Massager-----P63

## **Personal care -----P65**

## Sterile Surgical Atraumatic Thread

### **KHCKTRD01**

#### **Absorbable PGA Suture**

Component parts: Ethanoic Acid、Lactic Acid

Construction: Stranded Tight Braid

Absorption: By single resolving of water

Specification: USP8/0-2 #

Types of Needle Shape: 1/2circle ●○▲▼ (8mm-60mm)  
3/8circle ●○▲▼ (8mm-60mm)  
straight cutting ●○▲▼ (30mm-90mm)

Sterilization: Sterilized by Ethylene Oxygen.

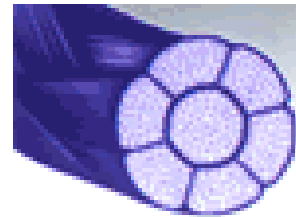

### **KHCKTRD02**

#### **Chromic Catgut (Absorbable) Suture**

Component parts: Composed by purified animal  
intestines(cattle and sheep)

Construction: Monofilament, Smooth Suture Surface

Absorption: Absorb by protease decomposition

Diameters of sutures: USP6/0-3 #

Types of Needle Shape: 1/2circle ●○▲▼ (8mm-60mm)  
3/8circle ●○▲▼ (8mm-60mm)  
Straight Cutting ●○▲▼ (8mm-60mm)

Sterilization: Sterilized by Gamma Radiation

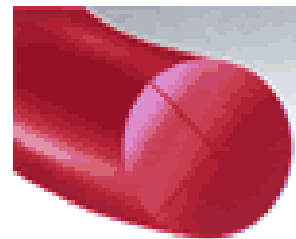

### **KHCKTRD03**

#### **Plain Catgut (Absorbable) Suture**

Component parts: Composed by purified animal  
intestines (cattle and sheep)

Structure: Monofilament, Smooth Suture Surface

Absorption: Absorb by protease decomposition

Diameters of sutures: USP6/0-3 #

Types of Needle Shape: 1/2circle ●○▲▼ (8mm-60mm)  
3/8circle ●○▲▼ (8mm-60mm)  
Straight Cutting ●○▲▼ (30mm-90mm)

Sterilization: Sterilized by Gamma Radiation



**KHCKTRD04**

**Silk (Braided) Suture**

Component part: Natural Silk

Structure: Braided strands

Absorption: Non-absorbable

Diameters of sutures: USP6/0-2 #

Types of Needle Shape: 1/2circle ●○▲▼ (8mm-60mm)

3/8circle ●○▲▼ (8mm-60mm)

Straight Cutting ●○▲▼ (30mm-90mm)

Sterilization: Sterilized by Gamma Radiation

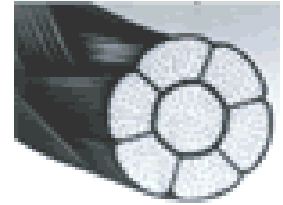

**KHCKTRD05**

**Nylon (Non-absorbable) Suture**

Component parts: Polypropylene (Nylon)

Structure: Monofilament, Smooth Suture Surface

Absorption: Non-absorbable

Diameters of sutures: USP10/0-2 #

Types of Needle Shape: 1/2circle ●○▲▼ (8mm-60mm)

3/8circle ●○▲▼ (8mm-60mm)

Straight Cutting ●○▲▼ (30mm-90mm)

Sterilization: Sterilized by Gamma Radiation

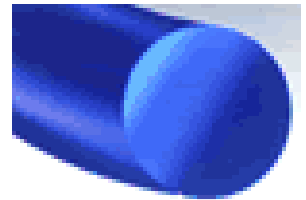

**KHCKTRD06**

**Polypropylene Suture**

Component part: Polypropylene

Structure: Monofilament, Smooth Suture Surface

Absorption: Non-absorbable

Diameters of sutures: USP10/0-2 #

Types of Needle Shape: 1/2circle ●○▲▼ (8mm-60mm)

3/8circle ●○▲▼ (8mm-60mm)

Straight Cutting ●○▲▼ (30mm-90mm)

Sterilization: Sterilized by Gamma Radiation

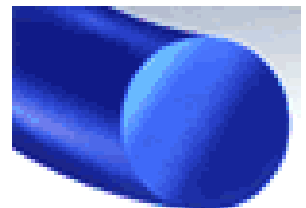

**KHCKTRD07**

**Polyester ( Braided ) Suture**

Component part: Polyester

Structure: Strands braided

Absorption: Non-absorbable

Diameters of sutures: USP6/0-2 #

Types of Needle Shape: 1/2circle ●○▲▼ (8mm-60mm)

3/8circle ●○▲▼ (8mm-60mm)

Straight Cutting ●○▲▼ (30mm-90mm)

Sterilization: Sterilized by Gamma Radiation

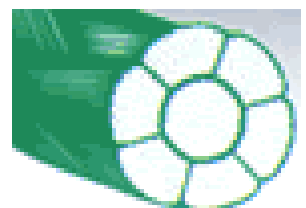

**KHCKTRD08**

**Stainless Steel Wire**

Component part: Polypropylene

Structure: Monofilament, Smooth Suture Surface

Absorption: Non- absorbable

Diameters of sutures: USP10/0-3#

Types of Needle Shape: 1/2circle ●○▲▼ (8mm-60mm)

3/8circle ●○▲▼ (8mm-60mm)

Straight Cutting ●○▲ (30mm-90mm)

Sterilization: Sterilized by Gamma Radiation

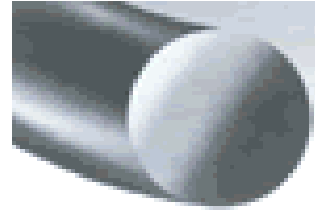

**Sterile surgical atraumatic**

**KHCKNDL01**

Main Target of Property:

Hardness:490—590HV0.2

Puncture force:≤0.78N

Elasticity: Deformed Drges≤2%

Effect of Irradiation sterilized effect: Sterilized

12 Pcs/box

50Box/carton

According to customer request



**Blade & Knife**

**KHCKBLD01**

**Disposable carbon steel surgical blades**

(Sterilized by Gamma Radiation)

Specs: No. 10, 11, 12, 14, 15, 18, 20, 21, 22, 23, 24, 25, 36.

**KHCKBLD02**

**Disposable stainless steel surgical blades**

(sterilized by Gamma Radiation)

Specs: No. 10, 11, 12, 14, 15, 18, 20, 21, 22, 23, 24, 25, 36.

**Package:**

100pcs/box

50boxes/carton

Design/package can be done according to customer request.



**KHCKBLD03**

**Disposable carbon steel surgical blades with plastic handle**

(sterilized by Gamma Radiation)

Specs: No. 10, 11, 12, 14, 15, 18, 20, 21, 22, 23, 24, 25



**KHCKBLD04**

**Disposable stainless steel surgical blades with plastic handle**

(sterilized by Gamma Radiation)

Specs: No. 10, 11, 12, 14, 15, 18, 20, 21, 22, 23, 24, 25.



**Package:**

Aluminium foil or PVC plastics.

10pcs/box

50boxes/carton

Design/package can be done according to customer request.

**KHCKBLD05**

**Stainless Steel Surgical Knife Handle**

(Sterilized by Gamma Radiation)

Specs:No.3, 4

Package: 10pcs/box



**KHCKBLD06**

**Disposable Steel Blood Lanlets**

(Sterilized by Gamma Radiation)

100pcs/box

50boxes/carton



**KHCKBLD07**

**Ophthalmic Knives**



## Scissors

### **KHCKSSRS01**

#### **Scissors, Operating**

Material: stainless steel

Specs:

S/S S/B B/B

Sharp/sharp sharp/blunt blunt

Straight Curved

Size: 12.5cm 14cm 16cm 18cm



### **KHCKSSRS02**

#### **Scissors, Metzenbaum**

Material: stainless steel

Specs: Curved

Size: 16cm 18cm 20cm 22cm 25cm



### **KHCKSSRS03**

#### **Scissors, Fine**

Material: stainless steel

Specs: delicate

Size: 18cm 20cm 22cm 25cm 26cm



### **KHCKSSRS04**

#### **Scissors, Dissect**

Material: stainless steel

Size: 15cm 18cm

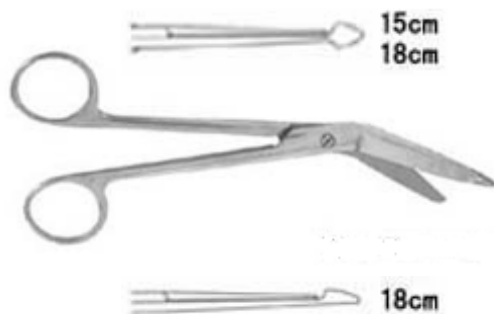

## Forceps

### **KHCKFCP01**

#### **Forceps, Hemostatic**

Material: stainless steel

Specs:

Straight/Curved

14cm 16cm 18cm 20cm 22cm 24cm

14cm 16cm 18cm

12.5cm 14cm 16cm 18cm 20cm 22cm 24cm

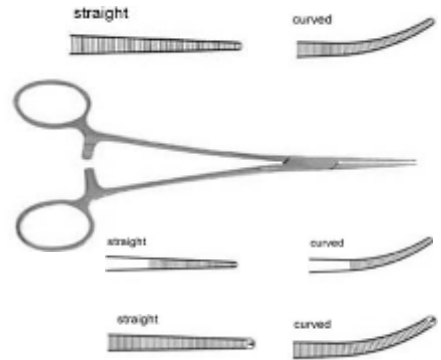

### **KHCKFCP02**

#### **Forceps, Sponge Holding**

Materials: stainless steel

Specs:

Straight/Curved

25cm 8mm

25cm 10mm

25cm 12mm

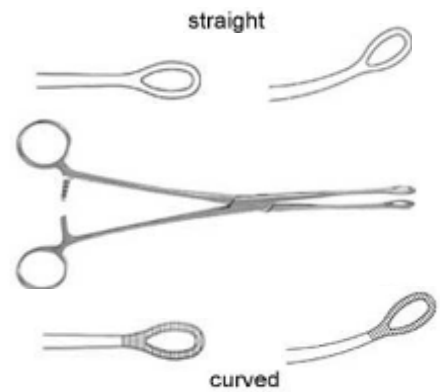

### **KHCKFCP03**

#### **Forceps, Towel**

Materials: stainless steel

Size: 9cm 10cm 11cm 14cm 16cm



**KHCKFCP04**

**Forceps, Allis/Tissue**

Materials: stainless steel

Specs

Size: 14cm 16cm 18cm

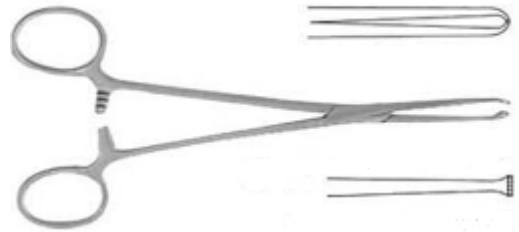

**KHCKFCP05**

**Forceps, Dressing**

Material: stainless steel

Specs

Size: 12.5cm 14cm 16cm 18cm 20cm 22cm 25cm



**KHCKFCP06**

**Forceps, Atraumatic**

Material: stainless steel

Specs: as in the pic

Size: 18cm tip 1.8

22cm tip 2.6



**KHCKFCP07**

**Forceps, Atraumatic**

Material: stainless steel

Size: 16cm tip 1.8/2.4/3.0

18cm tip 1.8/2.4/3.0

20cm tip 1.8/2.4/3.0

22cm tip 1.8/2.4/3.0

25cm tip 1.8/2.4/3.0



## Stethoscope

### **KHCKSTTHS01**

#### **Single head Stethoscope**

A professional stethoscope that monitors heart and respiratory sounds, and also detects fetal sounds. Medium chest piece. Chrome-plated or oxidized chest piece. Flat chest piece has single stem. Hard PVC ear tips. Matched colorful PVC tubing, binaural, chest piece are available.



### **KHCKSTTHS02**

#### **Dual-head Stethoscope**

Lightweight anodized aluminum chestpiece with color coordinated 22" PVC tubing. Chrome-plated brass binaurals adjusts easily for comfort. Chrome-plated external spring with white plastic eartips.



### **KHCKSTTHS03**

#### **Dual-head Stethoscope**

Constructed with an Zinc alloy bell & light weight chest piece to appreciate high/low frequency sounds with super acoustic sensitivity.



### **KHCKSTTHS04**

#### **Fetal type Dual-head Stethoscope**

Designed for superior auscultation of the fetal,  
Matched colorful PVC tubing and diaphragm rings are available.



**KHCKSTTHS05**

**Sprague Rappaport type Stethoscope**

Chrome-plated binaurals and fully rotatable chestpiece.  
22" tubes, Accessory kit includes: 2 Diaphragms,  
2 Pairs of ear tips,3 Bells. Colored chest piece can be  
matched the colorful latex free tubing.  
Gel colorful PVC tubes are also available.



**KHCKSTTHS06**

**Deluxe Single head Stethoscope**

Deluxe nickel-plated chest piece,  
Nickel-plated and internal spring binaural for  
professional purpose.



**KHCKSTTHS07**

**Deluxe Dual-head Stethoscope**

Features a developed new design  
chrome-plated zinc alloy chest piece,  
screw-on retaining ring, and internal spring binaural,  
matched tubing, and non-chill ring, for professional purpose.



**KHCKSTTHS08**

**Stainless Steel Cardiology type Stethoscope**

Features a stainless steel chest piece for maximum  
convenience, and internal spring binaural for high  
acoustic sensitivity. Dual non-chill rings provide  
patient comfort. Comes complete with additional one  
diaphragm and a pairs of ear-tips



**KHCKSTTHS09**

**Stainless Steel type Stethoscope**

Premium quality stainless steel chest piece  
offers superior clear sound transmission.  
Features in internal spring, stainless steel binaural,  
non-chill ring, and quality diaphragm.



### **KHCKSTTHS10**

#### **Visual Stethoscope**

The core technology of the Visual Stethoscope is from the professors of Tsing Hua University. It breaks the scope of the traditional clinic electrical products, and perfectly shows the design idea of making technology humanity. The product is suitable for use in family, hospital, social medical organizations, physical care in sports. The product has passed the FDA authorization (No. 510(K)-K050097), and got the right of sales in the Northern American and Canada.



## **Mercury (aneroid) sphygmomanometer**

### **KHCKMSGMN01**

#### **Desk type Mercurial Sphygmomanometer**

A Glass tube(3mm) B-3.2mm C-3.5mm  
Standard Cotton Cuff  
2-tube Adult size Bladder  
standard Latex Bulb  
Standard Valves  
Latex tube with connector



### **KHCKMSGMN02**

#### **Aluminum Plate Mercurial Sphygmomanometer**

Glass tube 3mm  
Standard Cotton Cuff  
2-tube Adult size Bladder  
standard Latex Bulb  
Standard Valves  
Latex tube with connector



### **KHCKMSGMN03**

#### **Mercurial Sphygmomanometer in big plastic box**

Mercurial Sphygmomanometer  
Single stethoscope  
Clinical thermometer, oral



**KHCKMSGMN04**

**Mercurial Sphygmomanometer in small plastic box**

Mercurial Sphygmomanometer

Single stethoscope



**KHCKMSGMN05**

**Desk stand type Mercurial Sphygmomanometer**

Cuff basket

glass tube 3.2mm

Standard Cotton Cuff

2-tube Adult size Bladder

standard Latex Bulb

Standard Valves

Latex tube with connector

PVC tube 2m



**KHCKMSGMN06**

**Wall type Mercurial Sphygmomanometer**

A-3.0mm/B-3.2mm/C-3.5mm

Cuff box

Standard Cotton Cuff

2-tube Adult size Bladder

standard Latex Bulb

Standard Valves

Latex tube with connector



**KHCKMSGMN07**

**Deluxe Mercurial Sphygmomanometer**

big bottle

Glass tube(3.5mm)

Standard Cotton Cuff(52 ~ 14.5cm)

2-tube Adult size Bladder

Standard Latex Bulb

Standard End Valve

Standard Valve

latex tube with connector(25CM)



**KHCKMSGMN08**

**Deluxe digital Mercurial Sphygmomanometer**

- big bottle
- Glass tube(3.5mm)
- blue nylon cuff with digital stethoscope
- Digital stethoscope
- 2-tube Adult size Bladder
- Standard Latex Bulb
- Automatic deflate Valve
- Standard End Valve



**KHCKMSGMN09**

**Stand type Mercury sphygmomanometer**

- Glass tube 4.0mm
- 3-wheel with hob
- Metal tube, Adjustable Height 108-150cm
- Standard Cotton Cuff
- 2-tube Adult size Bladder
- standard Latex Bulb
- Standard Valves
- Latex tube with connector



**KHCKMSGMN10**

**Aneroid sphygmomanometer**

- Standard Cotton Cuff
- 2-tube Adult size Bladder
- standard Latex Bulb
- Standard Valves
- Vinyl zipper bay



**KHCKMSGMN11**

**Aneroid sphygmomanometer with stethoscope**

- Single stethoscope
- Standard Cotton Cuff with D-ring
- size:54X 14.5cm
- 2-tube Adult size Bladder
- standard Latex Bulb
- Standard Valves
- Vinyl zipper bay



## Accessories for mercury

### Latex bag

| Description        | Size                |
|--------------------|---------------------|
| <b>KHCKMSGMN12</b> | new born 9x3cm      |
| <b>KHCKMSGMN13</b> | infant 19x5cm       |
| <b>KHCKMSGMN14</b> | child 20x9cm        |
| <b>KHCKMSGMN15</b> | adult 20x12cm       |
| <b>KHCKMSGMN16</b> | large adult 30x15cm |
| <b>KHCKMSGMN17</b> | thigh 35x18cm       |

Material: latex  
Color: black

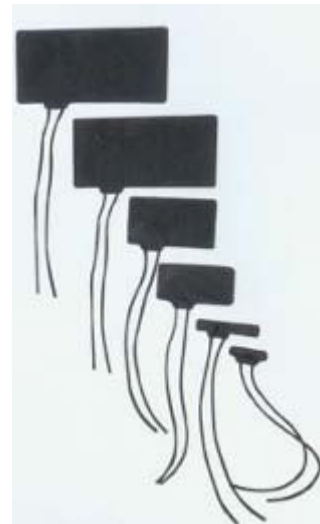

### Cuff

| Description        | Size               |
|--------------------|--------------------|
| <b>KHCKMSGMN18</b> | new born 25x5.5cm  |
| <b>KHCKMSGMN19</b> | infant 30x7cm      |
| <b>KHCKMSGMN20</b> | child 38x11cm      |
| <b>KHCKMSGMN21</b> | standard 52x14.5cm |
| <b>KHCKMSGMN22</b> | adult 56x14.5cm    |
| <b>KHCKMSGMN23</b> | adult 54x14.5cm    |
| <b>KHCKMSGMN24</b> | adult 52x14.5cm    |
| <b>KHCKMSGMN25</b> | thigh 78x22cm      |



### Accessory

| Description        | Size                              |
|--------------------|-----------------------------------|
| <b>KHCKMSGMN26</b> | cuff with metal hook 56x14.5cm    |
| <b>KHCKMSGMN27</b> | cuff with metal chip 56x14.5cm    |
| <b>KHCKMSGMN28</b> | nylon cuff with D-ring 56x14.5cm  |
| <b>KHCKMSGMN29</b> | cotton cuff with D-ring 56x14.5cm |
| <b>KHCKMSGMN30</b> | large adult cuff 66x17.5cm        |
| <b>KHCKMSGMN31</b> | lengthen cuff 100x14.5cm          |

Material: cotton nylon

## Thermometer

### **KHCKTHMM01**

#### **Armpit clinical thermometer (yellow back)**

Major and medium trumpet armpit clinical thermometer, outward appearance fine, the reading is clear (separately has yellow back, BaiBei and blue back), 35-42 or 94-108 pair of scale division, length 135mm, a single plastic tube packing 12 block,, 120 center box,, 720 paper box..



### **KHCKTHMM02**

#### **Oral cavity clinical thermometer**

The mercury clinical thermometer, Bai Bei and the yellow back, degree Celsius, mainly uses in the oral cavity. Accuracy: +0.1 -0.1 degree Celsius, length: 11CM, packing: 12/boxes, 720/box, gross weight/net weight: 8/7KGS.



### **KHCKTHMM03**

#### **Anus clinical thermometer**

The mercury clinical thermometer, mainly uses in the anus surveys the human body temperature, 35-42 degree Celsius. Each list plastic packing, 12 dozen, a 720 box.



### **KHCKTHMM04**

#### **Digital thermometer (general type)**

Temperature scope: 32.0-44.0 °C

The LCD arithmetic figure LCD shows

Mouth cavity, armpit, ass 3 usages

Only takes 60 second

Temperature memory



### **KHCKTHMM05**

#### **Digital Thermometer (flexible tip type)**

Temperature scope: 32.0-44.0 °C.

LCD arithmetic figure LCD shows

The Body temperature measurement can adopt the month cavity, armpit, and ass. Three method measurement

Measure time roughly 1 minute, can immediately get the body temperature, digital LCD shows. Voice tells.



It can keep the previous measurement of body temperature.

### **KHCKTHMM06**

#### **Digital thermometer (baby type)**

Just for infant the Digital thermometer of the measurement body temperature design.

This product is a safety, reading easily, fleetness, accurate Digital thermometer.

Temperature scope:32.0-44.0 °C.

LCD arithmetic figure LCD shows

The body temperature measurement can measures with the mouth cavity method.

Before measuring take a rest first three minutes, to make the mouth cavity inside body temperature stable.



## **ENT Endoscope**

### **KHCKEDS01**

#### **Sinoscope**

0°

φ2.7mmx175mm

φ3mmx60mm

φ3mmx95mm

φ3mmx175mm

φ3mmx110mm

φ4mmx50mm

φ4mmx90mm

φ4mmx110mm

φ4mmx175mm

φ5.5mmφ20mmx94mm

φ6.5mmφ20mmx78mm

φ8mmφ20mmx200mm

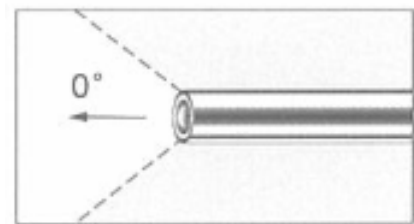

**KHCKEDS02**

**Sinoscope**

12°

φ3mmx175mm

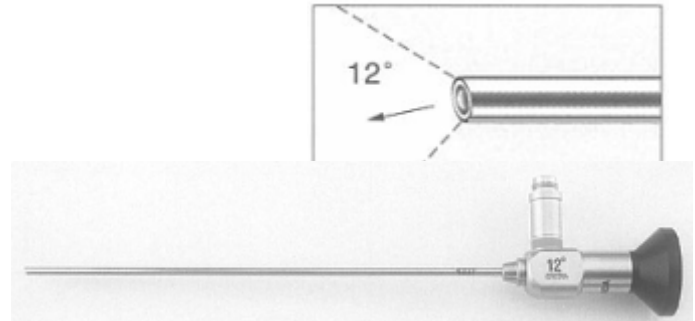

**KHCKEDS03**

**Sinoscope**

30°

φ2.7mmx175mm

φ3mmx90mm

φ3mmx175mm

φ4mmx90mm

φ4mmx175mm

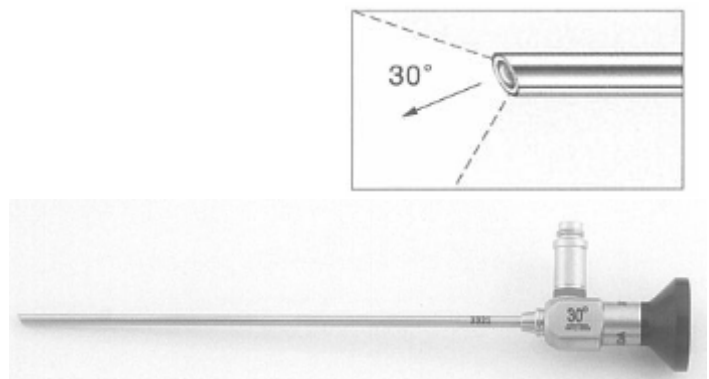

**KHCKEDS04**

45°

φ4mmx175mm

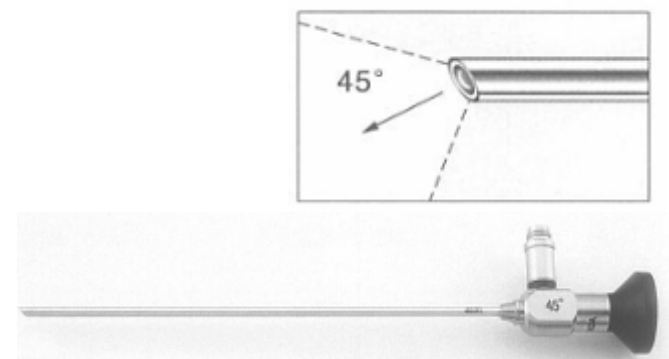

**KHCKEDS05**

70°

φ2.7mmx175mm

φ3mmx175mm

φ4mmx175mm

φ8mmx186mm

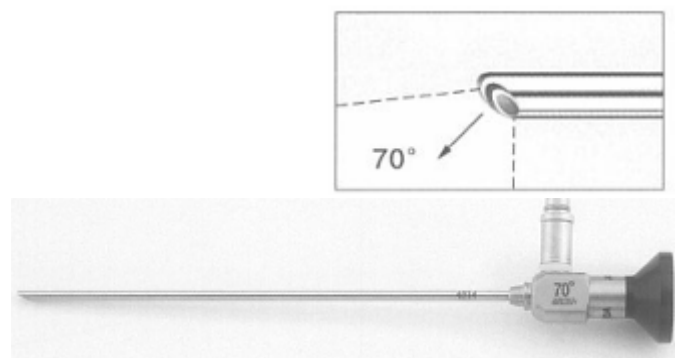

**KHCKEDS06**

**Laryngoscope**

90°

φ8mmx186mm

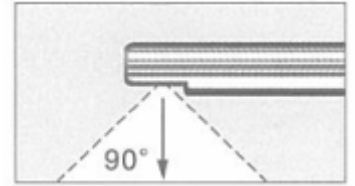

**KHCKEDS07**

**Sinoscope**

110°

φ4mmx175mm

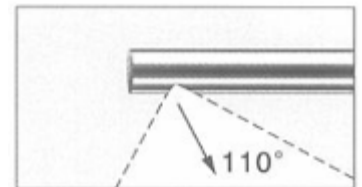

**Examine Lamp**

**KHCKEXL01**

**Big power LCD head lamp**

Big power and high brightness

Light spot is clear and adjustable

Universal voltage, apply to AC/DC

Can be connected to magnification and CCD photograph system

Power: 3W

Color Temperature: 6000K

Weight: 400g

Package: 31x21x18cm



**KHCKEXL02**

**LED head lamp**

Simple operation  
Cost effective  
Power: 1W  
Color Temperature: 6000K  
Weight: 350g  
Package: 28x18x15.5cm

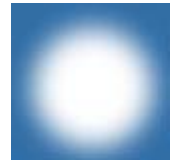

**KHCKEXL03**

**Focus and adjustable examination lamp**

High Tech  
Light spot clear and even  
2 light source Choice  
: Halogen or LED  
Light scope 30cm from the source: 1.8cm to 10cm  
Halogen           LED  
Voltage           30w           3w  
Brightness       75000lx       160lm  
Length of lamp 127cm       127cm



**KHCKEXL04**

**Micro focus examination lamp**

Tiny lamp head, light weight  
Can apply to AC voltage  
Easy to install  
High color temperature with low lamp temperature  
Can apply to AC /DC voltage, and can last for 4 hrs under DC situation  
Power: 3w  
Brightness: 160lm  
Length of the lamp: 60/130cm

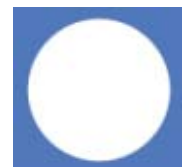

### **KHCKEXL05**

#### **Micro focus examination lamp**

Tiny lamp head, light weight

(Can apply to AC /DC voltage, and can last for 4 hrs under CD situation)

Easy to install

High color temperature with low lamp temperature

Power: 3w

Brightness: 160lm

Length of the lamp: 60/130cm



### **KHCKEXL06**

#### **Ordinary examination lamp**

Beautiful design and flexible

High brightness and wide scope of light

Simple and cost effective

Power: 30w

Color: 3000k

Brightness: 12000lx

Length of the lamp: 110cm

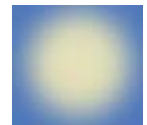

### **Facial Features Inspector**

#### **KHCKFFI01**

#### **Ear/Nose/Throat Diagnostic Set**

Ophthalmoscope x1

Otoscope carrier x1

Ear specula (3,4,5,6 mm diam) x4

Nasal speculum (8mm diam)x1

Dilating nasal speculum x1

Laryngeal mirror stem x1

Laryngeal mirror x3

Tongue depressor plastic x1

Battery handle x1

Spare bulbs (2 large and 4 small) x6



**KHCKFFI02**

**Ear/Nose/Throat Diagnostetic Set**

- Ophthalmoscope x1
- Otoscope carrier x1
- Ear specula(3,4,5,6 diam)x4
- Nasal apeculum (8mm diam)x1
- Dilating nasal speculum x1
- Laryngeal mirror stem x1
- Laryngeal mirros x3
- Tongue depressor plastic x1
- Battery handle x1
- Spare bulbs(2 large and 4 small) x6
- Transformer x1



**KHCKFFI03**

**Direct ophthalmoscope**

- Illumination form: big spot, small spot
- Diopter compensation: 0 ±1 ±2 ±3 ±4 ±5 ±6 ±8 ±10 ±12 ±16 ±20-25(D)
- Power supply: 1.5Vx2 C type battery
- Illumination bulb: 2.5V/0.3A



**KHCKFFI04**

**Direct ophthalmoscope**

- Illumination form: big spot, small spot
- Diopter compensation: 0 ±1 ±2 ±3 ±4 ±5 ±6 ±8±10 ±12 ±16 ±20-25(D)
- Power supply: 1.5Vx2 C type battery or AC 220v
- Illumination bulb: 2.5V/0.3A



**KHCKFFI05**

**Otoscope**

- Size of the aural: 3,4,5,6,8 mm
- Power supply: 1.5Vx2 C type battery
- Illumination bulb: 2.5V/0.3A



**KHCKFFI06**

**Otoscope**

- Size of aural: 3,4,5,6,8mm
- Power supply: AC220V, or 1.5Vx2 C type battery
- Illumination bulb: 2.5V/0.3A



**KHCKFFI07**

**Eye-examination instrument**

Components: ophthalmoscope diopters-examination and flashlight

Power: 1.5VX2 C type battery

Illumination bulb: 2.5V/0.3A

Battery handle: plastic



**KHCKFFI08**

**Eye-examination instrument**

Components: ophthalmoscope diopters-examination and flashlight

Power: 1.5VX2 C type battery AC220V

Illumination bulb: 2.5V/0.3A

Battery handle: metal



**KHCKFFI09**

**Mouth mirror**

Size: 21, 23, 27 (diameter, mm)

Model: Flat, concave



**KHCKFFI10**

**Laryngeal mirror**

Size: 10,12,14,16,18,20,22 (diameter, mm)



**KHCKFFI11**

**Skin magnifier**

It is used for magnifying(10 times)

Powder supply : 1.5Vx2 AA

Bulb: 2.5V/0.3A



**KHCKFF12**

**Eye sight lamp box**

Frame: high strength aluminum alloy  
Spray coating  
Organic glass



**Tongue Depressor**

**KHCKTD01**

**Tongue Depressor**

Ways of sterilize: Ethylene Oxide(EO)  
Size: 150x18x1.6mm  
Package: individual paper bag



**KHCKTD02**

**Tongue Depressor**

Ways of sterilize: gama irradiation  
Size: 150x18x1.6mm  
Package: individual plastic/paper bag



## Infusion equipment

### Disposable syringe (3 parts) 1~50ml

| Item No.  | Size | Type   | General needle size | Service scope                  |
|-----------|------|--|---------------------|--------------------------------|
| KHCKIFS01 | 1ml  | Luer slip Centric nozzle                                       | 27G~23G             | Ophthalmology, dentistry, etc. |
| KHCKIFS02 | 2ml  | Luer slip Centric nozzle                                       | 25G~23G             | Intramuscular injection        |
| KHCKIFS03 | 3ml  | Luer slip/luer lock Centric nozzle                             |                     |                                |
| KHCKIFS04 | 5ml  | Luer slip/luer lock Centric nozzle                             |                     |                                |
| KHCKIFS05 | 10ml | Luer slip/luer lock Centric nozzle                             | 20G or 18G          | For dosage during infusion     |
| KHCKIFS06 | 20ml | Luer slip/luer lock Centric nozzle, Luer slip Eccentric nozzle | 22G~18G             | Intravenous infusion of liquid |
| KHCKIFS07 | 30ml | Luer slip/luer lock Centric nozzle, Luer slip Eccentric nozzle |                     |                                |
| KHCKIFS08 | 50ml | Luer slip/luer lock Centric nozzle, Luer slip Eccentric nozzle |                     |                                |

### Disposable syringe (2 parts)

| Item No.  | Size | Type                                      | General needle size | Service scope                  |
|-----------|------|---|---------------------|--------------------------------|
| KHCKIFS09 | 2ml  | Lure slip Centric nozzle                  | 25G~23G             | Intramuscular injection        |
| KHCKIFS10 | 5ml  | Lure slip Centric nozzle/Eccentric nozzle | 25G~22G             |                                |
| KHCKIFS11 | 10ml | Lure slip Eccentric nozzle                | 20G or 18G          | For dosage during infusion     |
| KHCKIFS12 | 20ml | Lure slip Eccentric nozzle                | 22G~18G             | Intravenous infusion of liquid |

### Disposable insulin syringe

| Item No.  | Size | Type                     | General needle size | Service scope     |
|-----------|------|--------------------------|---------------------|-------------------|
| KHCKIFS13 | 1ml  | Lure slip Centric nozzle | 29G,30G             | Insulin injection |

### Disposable Auto destroy syringe

| Item No.  | Size | Type                                     | General needle size | Service scope           |
|-----------|------|--|---------------------|-------------------------|
| KHCKIFS14 | 3ml  | Three-part(F)/Five-part(M), Central type | 25G~22G             | Intramuscular injection |
| KHCKIFS15 | 5ml  | Three-part(F)/Five-part(M), Central type | 23G~22G             | Intramuscular injection |

**Infusion set**

| Item No.  | Type  | Description  | Service scope   |
|-----------|-------|--|---|
| KHCKIFS16 | IS-V  | A connection type of injection moulding drip chamber and plastic spike | With air inlet device, applicable to the infusion vessel needing ventilation(temporary adding medicine from rubber tube). |
| KHCKIFS17 | IS-CD | A separation type of blow molding drip chamber and plastic spike.      | With air inlet device, applicable to the infusion vessel needing ventilation(temporary adding medicine from rubber tube). |

**Blood transfusion set**

| Item No.  | Type | Description  | Service scope  |
|-----------|------|--|--|
| KHCKIFS18 | XV   | A connection type of injection moulding drip chamber and plastic spike | With air inlet device, applicable to the blood transfusion vessel needing ventilation(temporary adding medicine from rubber tube). |

**Scalp vein needle**

| Item No.  | Symbol                            | Needle type(G) | Service scope  |
|---|-----------------------------------|----------------|--|
| KHCKIFS19<br>Scalp Vein Needle (single wing/double wings) | Needle type×Needle cannula length | 27~23          | Applicable to the intravenous infusion (transfusion) for children. |
|   |                                   | 22~18          | Applicable to the intravenous infusion(transfusion) for adult.     |

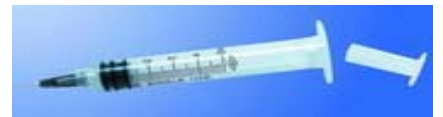

## **KHCKIFS20**

### **Infusion pump**

#### Front

1. Handle
2. Warning lights
3. LCD screen
4. Presetting data keys / Function keys
5. Button panel
6. Auxiliary handle of operation
7. Door handle



#### Side

8. Auxiliary handle of operation
9. Fixed knob

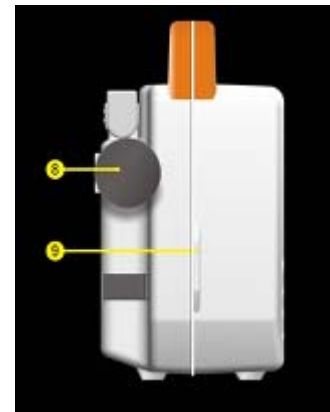

#### Back

10. Drop detector
11. Alliance of drop detector
12. Drop detector socket
13. Power socket
14. Power Switch
15. Data interface
16. Fixed knob
17. Non-slip rubber mat

#### Product Characteristics

1. Application of a variety of one-off general infusion devices
2. Ultra-durability and low noise body structure
3. Precise infusion control and automatically correction of precision
4. Two control modes: volume and drop
5. Unique infusion data presetting function
6. Convenience dismounting battery
7. English operating system
8. Reliable whole series of security detection and alarm system
9. High alarm lights
10. The data interface can be connect with network of the nurse station (Alternative)

#### Alarm and Indicator Function

1. Air and solution emptying
2. Up occlusion
3. Down occlusion
4. Infusion complete
5. Installing error of infusion device

6. Door open
7. Insufficient voltage of battery
8. Infusion operation
9. Purge operation
10. Safety detection and control of circuit fault

#### Parameters

1. Mechanical principle: Finger- peristaltic
2. Two operation modes: "volume controlled infusion" and "drop controlled infusion" .
3. Uses: Any medical situation needs intravenous infusion or intestine nutrition.
4. Three models' infusion rate range: 1~600 ml/h, 1~1200 ml/h, 1~2500ml/h.
5. Medical Device Product Management Categories: The second category.
6. Equipment type: Portable equipment.
7. Electric Shocks Protection Classification: Class II-B.
8. Coat Protection Grade: IP33
9. Noise: 48dB/350mm
10. Using environment: temperature 5 °C to 40 °C, humidity 35%-85%, atmospheric pressure 860~1060hPa
11. Mechanical stability: it can operate normally even placed horizontally
12. Applicable infusion stand: it can be fixed on diameter of 10mm~28mm of poles.
13. Accuracy :  $\pm 2\%$
14. Occlusion detection sensitivity: 0. 03N
15. Net weight: 2 kg.
16. Size: 140 (W) x 120 (D) x 220 (H) mm
17. Power:  $\leq 15W$
18. Input voltage: AC220V  $\pm 20\%$  / 50Hz or DC12V (can be customized by user's order)
19. Battery: Ni-MH battery 12. 5V, 1800mAh.



## First Aid Bandage

### **KHCKFAB01**

#### First aid bandages

Material: fabric/non woven/PE/PU/PVC

Shape: tube, H shape, butterfly shape, round

Size: according to customer request

Package: one size or mixed/box



### **KHCKFAB02**

#### Aloe wound protection bandage

Contains aloe extract. The active components in Aloe extract have the ability of restoring wound.

Size: according to customer request



## Hydrogel Dressing

### **KHCKGELD01**

Usage:

Burn cure

Burn wound of I degree, low II degree, and deep II degree with a little trend to low.

Deep II degree burn wound after cutting scar.

Surface ulcer cure

Ulcer, diabetes mellitus foot ulcer, decubital ulcer, and radioactivity skin injury caused by pathological changes of crura vein.

Epidermis injury caused by other trauma

Wound by surgery and orthopedic operation

General (HD-L): 20\*12.5cm<sup>2</sup>, 12\*8cm<sup>2</sup> Enlargement (HD-M) : 20\*12.5cm<sup>2</sup>, 12\*8cm<sup>2</sup>

[Characteristic Mechanism and Clinical represent]

| Characteristic  | Mechanism  | Clinical represent   |
|---|--|--|
| Include abundant free water, bound water and combined water | Cool the wound swift                                     | Reduce the severity of the pain, prevent deeper injury                         |
|   | Create and maintain a dampish condition for concrescence | Accelerate wound cicatrisation; shorten cure cycle; alleviate scar hyperplasia |
| Special three dimensional network structure                 | Semi-permeability  | Obstruct bacteria; prevent infection; allow oxygen and water to via            |
|   |  |  |

|                                  |  |  |
|----------------------------------|--|--|
|                                  | High machine strength, highly clarity  | Easy to operate and observe  |
| Good biocompatibility            | Adhere firmly yet gently to the healthy surface; not adhere to wet wound surface | painless when exchange for another; avoid mechanical injury for the second time                  |
| Advanced manufacturing technique | Gel formation and sterilization are accomplished simultaneously in one step      | High purity; no toxic, no stimulate, no sensitization; long storage life, general save condition |

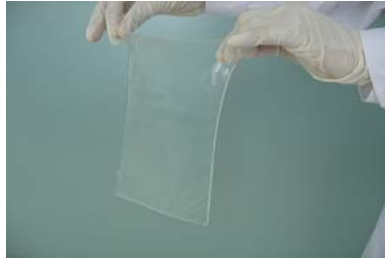

## Swab

### **KHCKSWB01**

#### **Haemostatic gauze**

Made of pure cotton fiber which is extracted from plant  
 Dissolve in water  
 No structured toxicity. Neither irritating nor allergic to human body  
 It can break down to low molecular saccharine in human body  
 Capacity of water absorption: more than 30 times the weight of its own  
 Loss on drying: less than 12%  
 Water insoluble portion: less than 10%  
 Ph: 7-8



### **KHCKSWB02**

#### **Gauze swab**

100% cotton  
 Absorbency  $\leq 3s$   
 Whiteness level  $\geq 82\%A$   
 Renewable and easy to recycle



X-Ray thread

With/with out X-Ray thread incorporated in to  
The sponge  
Sterile  
Size: 5x5 7.5x7.5 10x10 10x12.5 10x15 10x20 15x20 20x30 (cm)  
Plies: 8p, 12p, 16p, 24p, 32p

**KHCKSWB03**

**Fluff gauze swab**

Soft and highly absorbent  
Manufactured of pre washed  
Fluff dried woven gauze and protection for sensitive wound areas  
Size: 6"x6.75" 7.75"x8.75" 9.75"x10.75"  
Plies: 12p, 16p

**KHCKSWB04**

**Vaseline gauze swab**

White/yellow Vaseline  
Leno gauze  
Size: 10x10cm

**KHCKSWB05**

**Non woven swab**

70% rayon+30%polyester  
Soft and higly absorbent  
No lint  
Size: 5x5 7.5x7.5 10x10 10x20 15x15(cm)  
Plies: 4p, 6p, 8p

**KHCKSWB06**

**Cotton swab**

Soft and 100% natural  
White fiber  
Highly absorbent  
Size: 3x4 4x4 7.5x7.5 8x8 10x10 10x16 (cm)

**KHCKSWB07**

**Zigzag cotton swab**

100% cotton  
White fibber  
Easy to tear  
Spec: 10, 25, 50,100,200,250,500 g/poly bag



## Gauze ball

### **KHCKGB01**

#### **Cotton gauze ball**

100% cotton gauze yarn, surgical grade  
With or without X-Ray detectable yarn  
Shape: round, oval, flat, stripe, hate form, petal

### **KHCKGB02**

#### **Non woven ball**

70% rayon+30% polyester  
Soft, highly absorbent  
No lint  
With/without elastic ring  
30g/m<sup>2</sup>, 40g/m<sup>2</sup>, 50g/m<sup>2</sup>  
Size:  $\Phi$ 2,2.5,3,3.5,4,4.5,5,5.5,6,6.5, 7 (cm)



## Bandages

#### **Gauze bandage**

100% cotton  
High breath ability  
Applicable to infirmary and first aid  
Used for the fixing and holding of injured joint or fractured part  
Soft and comfortable



### **KHCKB01**

W.O.W gauze bandage  
Size (cmxm): 5x500, 7.5x500, 10x500, 15x500, 20x500

### **KHCKB02**

Gauze bandage with woven edges  
Size (cmxm): 2.5x5, 5x5, 7.5x5, 10x5, 15x5, 20x5



**KHCKB03**

**Crochet gauze bandage**

Size (cmxm): 2.5x5, 5x5, 7.5x5, 10x5, 15x5, 20x5



**KHCKB04**

**Shrinking gauze bandage**

Size(cmxm):5x4, 7.5x4, 10x4, 15x4, 11.25x3.5

Plies: 4p, 6p



**KHCKB05**

**Triangular bandage**

Soft, comfortable

Convenient for fixing of limbs

| 100% cotton | Size(cmxcmxcm) |
|-------------|----------------|
| 40'Sx40'S   | 90x90x127      |
| 48x48       | 95x95x135      |
| 50x50       | 90x90x130      |
| 68x63       | 105x105x150    |
| Non-woven   |                |
| 20g/m2      | 90x90x127      |
| 30g/m2      | 95x95x136      |
| 45g/m2      |                |

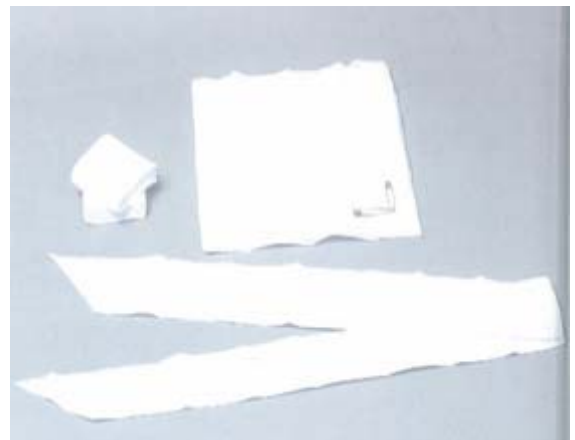

**KHCKB06**

**Plaster bandage**

Most effective, safe and widely used products

In orthopaedics

Few paste powder running off when soaked in water

Solidification time can be controlled within 2-8min

Size(cmxm): 5x2.7, 5x3, 5x4.6,7.5x2.7, 7.5x3



**KHCKB07**

**Cotton adhesive elastic bandage**

Can be used for strains and sprains

Used for hot/cold packs

Promote circulation and healing

Control swelling and stop bleeding

Can be used as veterinary bandage

Usage: for strains and sprains. Fixing bandage for hot/cold packs. Control swelling and stop bleeding.

Size(cm $\times$ cm): 2.5x450, 5x450, 7.5x450, 10x450

Color: white with/without yellow middle line

Flesh with/without red middle line

### **KHCKB08**

#### **Poly-cotton cohesive flexible bandage**

A: 70% cotton, 30% polyamide

Can stick to itself, no need of pins or clips.

Do not stick to hair, skin, and clothes

Soft and breathable

Light pressure, will not avoid blood circulation

Size(cm $\times$ m): 4x20, 6x20, 8x20, 10x20, 12x20, 4x4, 6x4, 8x4, 10x4, 12x4

Color: white



### **KHCKB09**

#### **Poly-cotton cohesive flexible bandage**

B: 40% cotton, 60% polyamide

Can stick to itself, no need of pins or clips.

Do not stick to hair, skin, and clothes

Soft and breathable

Light pressure, will not avoid blood circulation

Usage:

Size(cm $\times$ m): 4x20, 6x20, 8x20, 10x20, 12x20, 4x4, 6x4, 8x4, 10x4, 12x4

Color: white



### **KHCKB10**

#### **Non-woven cohesive flexible bandage**

Elastic non-woven substrate/ elastic non-woven substrate with latex free

Self stick. No stick to hair, clothes, skin.

Breathable

Hand tear. No need of scissors

Competitive price

Usage: usage for strains and sprains. Fixing bandage for splints, monitors and IVs. First aid bandages. Can be used for animal wrapping.

Size(cm $\times$ cm): 2.5x450, 5x450, 7.5x450, 10x450, 15x450

Color: white/tan/red/blue/green/yellow

### **KHCKB11**

#### **Cotton cohesive flexible bandage**

Elastic cotton substrate/ Elastic cotton substrate with latex free

Self stick. No stick to hair, clothes, skin.

Breathable

Hand tear. No need of scissors

Usage: usage for strains and sprains. Fixing bandage for splints, monitors and IVs. First aid bandages.

Size(cmxcn): 2.5x450, 5x450, 7.5x450, 10x450, 15x450

Color: white/Tan/black



### **KHCKB12**

#### **Cotton athletic tape**

Cotton substrate/cotton substrate with latex free

Non elastic.

Plain/zigzag edge. Easy to tear lengthwise and widthwise

Leaves no residue on body parts

Usage: for strains and sprains. Fixing bandage for hot/cold packs.

Control swelling and stop bleeding. Sports equipment binding.

Size(cmxcn): 2.5x1370, 3.8x1370, 5x1370

Color: bleached white



## **Adhesive Tape**

### **KHCKB13**

Water proof

Strong adhesions

For support and protection against injuries

Easy to tear

High breath ability.

No damage skin

Material: Cotton/Non-woven/PE/Paper

Size(cmxcn): 1.25x1, 1.25x5, 1.25x10, 2.5x1,  
2.5x5, 2.5x10, 5x5, 7.5x5, 7.5x10, 10x5, 10x10



## Adhesive Plaster

### **KHCKB14**

Soft, can stretch freely

Good breath ability and conformability

No damage to skin

Specs: zinc oxide adhesive plaster/  
drilling adhesive plaster with medicine

Size: 1.25x1, 1.25x5, 1.25x10, 2.5x1, 2.5x5, 2.5x10,  
5x5, 5x10, 7.5x5, 7.5x10, 10x5, 10x10

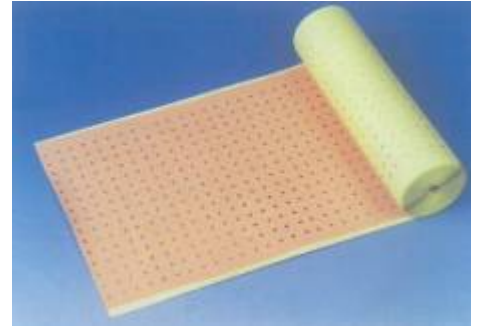

## First aid kits

### **KHCKFAK01**

SIZE: 320x240mm

Medical product list:

S001 Wound compress(non-woven), size 10cmx10cm, sterilized, cover wound 5

S002 Combine A.B.D pad, 20cmx20cm, used to stypsis 10

N003 Non-woven tape, size 2.5cmx400cm,put in self-sealed pocket plastic pocket with label 1

S004 Elastic bandage(with polymers), size 8cmx450cm, put in PE pocket with label,sealed and sterilized ,cover wound bandage in place 1.



S005 Elastic bandage , size 8cmx400cm, put in PE pocket with label, sealed and sterilized ,cover wound bandage in place. 1

N006 Scissors, size 14.5cm, stainless steel material, put in PE pocket with label, sealed and sterilized tear-off clothing 1

N007 emergency blanket ,packed in self-sealed bag with 1 label, unfolded size 210cmx160cm, folded size 13cmx8.5cm 1

S008 Gauze pad, size 4cmx4cm, put in one side paper and one side plastic packet, sterilized, cover small wounds 5

S009 Gauze pad, size 8cmx 8cm, put in one side paper and one side plastic packet, sterilized, cover small wounds 1

- N010 Iodine prep pad, size 6.5cm×3cm, used to disinfect 2  
 S011 NaCl humid tissue, cleaning wounds 1  
 N012 Triangle bandage, size 96cm×96cm×136cm, folded size 13cm×18cm, packet in pillow shape with 1 label immobilize and keep splints in place 1  
 N013 Single use gloves, large size, every 2 units packed in self-sealed plastic pocket, protect against infections 2  
 N014 Safety pins, 3cm, put in self-sealed pocket with 1 label, keep bandage in place 6  
 S015 Adhesive bandage, size 7.2cm×1.9cm, cover small wounds 8  
 N016 Tweezer (plastic material), size 12cm, put in self-sealed pocket with 1 label, avoid cross infection 1  
 S017 Mouth to mouth mask, 20cm×20cm, used for artificial respiration 1  
 S018 Alcohol pieces. Size 6.5cm×3cm, used to disinfect 4  
 S019 Absorb the blood mat, size 10×10cm, cover wounds 3  
 N020 Cold pack, 200g, used to burn 1  
 S021 Elastic bandage, size 6cm×400cm, put in PE pocket with label, sealed and sterilized, cover wound bandage in place 1  
 S022 Gauze bandage, size 8cm×600cm, packed in pillow shape with glassine, sterilized, fixed wound dressing 1  
 N023 Multi-purpose bandage, size 5cm×450cm, put in PE pocket with label, cover wound compress in place. 1  
 N024 First Aid Guide 1  
 N025 Outer bag, store products using for first aid kit. 1  
 N means not sterilized, S means sterilized.

**KHCKFAK02**

Medical product list:

|                                  |    |        |
|----------------------------------|----|--------|
| Blood-stopper bandage            | 1  | piece  |
| Yunnan baiyao powder             | 1  | bottle |
| PVC gloves                       | 2  | pair   |
| Adhesive bandage 72 mm×19mm      | 20 | piece  |
| Iodine cotton bar 7cm            | 30 | piece  |
| Iodine cotton ball 5pcs/bag      | 10 | bag    |
| Adhesive wound dressing 6×7cm    | 10 | piece  |
| Adhesive wound dressing 8×9cm    | 5  | piece  |
| Adhesive wound dressing 10×10cm  | 5  | piece  |
| Dressing pad 7.5×7.5cm           | 10 | piece  |
| Dressing pad 10×10cm (2pcs/bag)  | 2  | bag    |
| Fingertip fracture splint 7×11cm | 1  | piece  |
| Electronic thermometer           | 1  | piece  |
| Medical tweezers plastic         | 1  | piece  |
| Safety pin metal                 | 1  | piece  |
| First aid blanket sliver         | 2  | piece  |
| Compress for burns 40×60cm       | 1  | bag    |



|                               |                |          |
|-------------------------------|----------------|----------|
| Compress for burns            | 60×80cm        | 1 bag    |
| Alcohol cotton ball           | 30pcs/ball     | 1 ball   |
| Triangular bandage            | 90 x 90×129 cm | 2 piece  |
| Safety pin                    |                | 4 piece  |
| Self-adhesive elastic bandage | 10cm×2. 5m     | 2 roll   |
| Self-adhesive elastic bandage | 5cm×2. 5m      | 8 roll   |
| Fracture splint in roll shape |                | 1 roll   |
| Burn plaster                  |                | 1 bottle |
| Traveling first aid bag       | 12×7×5 cm      | 1 piece  |
| Glisten vest                  |                | 1 piece  |
| Cooling gel sheet             | single package | 2 piece  |
| Tongue spatula                |                | 4 piece  |
| Breath freshener spray        |                | 1 bottle |
| Huoluo oil                    | 5ml            | 1 bottle |
| First aid instruction         |                | 1 page   |
| First aid bag                 | 22×32×10 cm    | 1 piece  |

### **KHCKFAK03**

Size: 460x180mm, Folded size: 180x115x60mm

Medical product list:

- S001 Wound compress, size 60cm×40cm, put in one side paper and one side plastic packet, sterilized, cover small wounds 1
- S002 NaCl humid tissue, cleaning wounds 2
- S003 Disinfect gauze pad ,size 8cm×8cm, every 1 units packed in 2 sides paper pocket, sterilized, cover wounds 4
- N004 Adhesive plastic, size 1.25cm×500cm, put in self-sealed plastic pocket with 1 label, keep bandage in place 1
- S005 Adhesive dressing, size 10cm×6cm, packed in a self-sealed plastic pocket with 1 label, cover small wounds 8
- S006 Single use gloves, large size, every 4 units packed in self-sealed plastic pocket, protect against infections 4
- N007 Non-woven triangle cloth, size 96cm×96cm×136cm, folded size 13cm×18cm,packed in pillow shape with label immobilize and keep splints in place 1
- N008 High-carbon scissor, size 15cm, high-carbon material, put in PE pocket with label, tear off clothing 1
- N009 Safety pins, 3cm, put in self-sealed pocket with 1 label, keep bandage in place 4
- S010 Disinfect gauze pad ,size 4cm×4cm, every 1 units packed in 2 sides paper pocket , sterilized, cover wounds 4
- S011 Gauze bandage, size 5cm×500cm, packed in pillow shape with glassine, sterilized, fixed wound dressing 2
- S012 Adhesive bandage, size7.2cm×1.9cm, cover small wounds8
- N013 Emergency blanket, packed in self-sealed bag with 1 label, unfolded size 210cm×160cm, folded size 13cm×8.5cm protect against heat and coldness 1



- S014 Gauze bandage, size 8cm×400cm, packed in pillow shape with glassine, sterilized, fixed wound dressing 3  
 N015 Alcohol prep pad. Size 6.5cm×3cm, used to disinfect 4  
 N016 First aid guide 1  
 N017 Zipper pocket ,store product using for first aid 1  
 N means not sterilized, S means sterilized

**KHCKFAK04**

Medical product lists:

- N001 Clinical thermometer, for measuring temperature. Piece 1  
 N002 Scissor, for cutting medical gauze. Piece 1  
 S003 Wound protection paste, for protecting the wound and diminishing inflammation & haemostasis. Piece 10  
 S004 75% alcohol cotton ball or alcohol prep pad, for the disinfection and cleaning of skin and commodity. Bag 2  
 S005 Iodine prep bar, for the disinfection of normal wounds, flycuts, brush-burns and scalds, and also for cutaneous infection. Bag 2  
 S006 Medical cotton carriers, for cleaning the wounds. Bag 4  
 N007 Rubberized fabric, for fixing the dressing. Roll 1  
 S008 Medical gauze pad, for protecting or cleaning the wounds. Piece 5  
 S009 Medical bandage, for dressing the wounds. Roll 1  
 N means not sterilized, S means sterilized



**KHCKFAK05**

Medical product list:

- |                         |                     |    |       |
|-------------------------|---------------------|----|-------|
| Adhesive bandage        | 72×19mm             | 12 | piece |
| Iodine cotton bar       | 7cm                 | 24 | piece |
| Wound dressing pad      | 6×7cm               | 5  | piece |
| Wound dressing pad      | 8×9cm               | 5  | piece |
| Wound dressing pad      | 10×10cm             | 5  | piece |
| Dressing pad            | 5×5cm               | 5  | piece |
| Dressing pad            | 7.5×7.5cm           | 5  | piece |
| Dressing pad            | 10×10cm (2pcs/bag.) | 2  | bag   |
| Scissors metal          |                     | 1  | piece |
| Tweezers plastic        |                     | 1  | piece |
| Iodine cotton ball      | 5pcs / bag          | 1  | bag   |
| Alcohol cotton prep pad | 5cm×5cm             | 4  | piece |
| First aid blanket       | 208×132 cm          | 1  | piece |
| Triangle bandage        | 90×90×129 cm        | 1  | piece |
| PBT elastic bandage     | 10×450cm            | 1  | roll  |



|                       |               |   |       |
|-----------------------|---------------|---|-------|
| PBT elastic bandage   | 5×450cm       | 1 | roll  |
| Adhesive tape         | 1cm×10m       | 1 | roll  |
| Safety pins           |               | 4 | piece |
| Month-to-mouth mask   |               | 1 | piece |
| Instant ice bag       | 100g          | 1 | bag   |
| Thermometer           |               | 1 | piece |
| First aid booklet     |               | 1 | book  |
| First aid instruction |               | 1 | page  |
| First aid bag         | 21×14.5×6.5cm | 1 | piece |

Adhesive bandage: Used to bind the small wound.

Iodine cotton bar: Used to disinfect the small wound. Single package.

Wound dressing: To cover small wounds.

Dressing pad: To stop the blood. It can use to fix on the wound with the self adhesive bandage.

Scissors: Used to cut down the bandage or entangled clothes.

Tweezers: Used to clip iodine cotton ball or some attached variant dressings on the wound.

Iodine cotton ball: It can kill large area of the bacteria, also can use for sterilizing, cleaning.

Alcohol cotton prep pad: Used to disinfect the wound or thermometer .or used to disinfect the hand.

First aid blanket: To cover against coldness and heat.

Triangular bandage: Used to fixing the fracture splint .for example .you can hung the triangular bandage in your neck when you meet the fracture.

PBT elastic bandage: Used to stopping the blood or fastness, bind the wound after the wound was covered by the wound dressing or dressing pad.

Adhesive tape: Used to fixing the dressing (wound dressing, dressing pad) material.

Safety pin: Used to fix the triangular bandage.

Mouth -to-mouth mask: Used for the mouth-to-mouth artificial respiration, in the case of bacteria infection during the respiration.

Instant ice bag: To activate, squeeze pack until inner pouch bursts. Shake pack well to mix contents after activation. Apply cold pack to desired area. Dispose of cold pack in proper receptacle.

Thermometer: used to measure the body temperature

### **KHCKFAK06**

Medical product list:

|                         |    |       |
|-------------------------|----|-------|
| Scissors                | 1  | Piece |
| Tweezers                | 1  | Piece |
| Wound dressing pad      | 1  | Piece |
| Wound dressing pad      | 1  | Piece |
| Dressing pad            | 2  | Piece |
| Dressing pad            | 2  | Piece |
| Iodine cotton bar       | 15 | Piece |
| Alcohol cotton prep pad | 10 | Piece |
| Month-to-mouth mask     | 1  | Piece |



|                          |    |       |
|--------------------------|----|-------|
| First aid blanket        | 1  | Piece |
| Cool gel sheet           | 2  | Piece |
| Gauze bandage            | 1  | Piece |
| Triangle bandage         | 1  | Piece |
| PBT elastic bandage      | 1  | Roll  |
| PVC gloves               | 1  | Pair  |
| Iodine cotton ball       | 5  | Piece |
| Cleaning humid tissue    | 1  | Piece |
| Sterilizing humid tissue | 1  | Piece |
| Adhesive bandage         | 4  | Piece |
| Adhesive bandage         | 4  | Piece |
| Adhesive bandage         | 10 | Piece |
| Eye pad                  | 1  | Piece |

## Foldaway Stretcher

### **KHCKFAFS01**

unfolded size(LxWxH): 185x52x20cm

folded size(LxWxH): 94x52x9cm

net weight: 6kg

Bearing: 159kg

Material:aluminum alloy, oxford cloth

Packing: 2pcs/carton

Carton size: 96x53x18cm

Gross weight: 13kg



### **KHCKFAFS02**

unfolded size(LxWxH): 185x52x24cm

folded size(LxWxH): 94x52x12cm

net weight: 8kg

Bearing: 159kg

Material:aluminum alloy, oxford cloth

Packing: 2pcs/carton

Carton size: 96x53x28cm

Gross weight: 19kg



### **KHCKFAFS03**

unfolded size(LxWxH): 185x52x3cm

folded size(LxWxH): 94x52x7cm

net weight: 3.3kg

Bearing: 159kg



Material:aluminum alloy, oxford cloth  
Packing: 2pcs/carton  
Carton size: 96x53x16cm  
Gross weight: 8kg

**KHCKFAFS04**

unfolded size(LxWxH): 185x50x3cm  
folded size(LxWxH): 94x50x7cm  
net weight: 7kg  
Bearing: 159kg  
Material: aluminum alloy  
Packing: 1pcs/carton  
Carton size: 96x53x9cm  
Gross weight: 8kg



**KHCKFAFS05**

unfolded size(LxWxH): 185x50x3cm  
folded size(LxWxH): 46x50x13cm  
net weight: 4kg  
Bearing: 159kg  
Material:aluminum alloy, oxford cloth  
Packing: 1pcs/carton  
Carton size: 52x51x18cm  
Gross weight: 5kg



**KHCKFAFS06**

unfolded size(LxWxH): 215x55x50x15cm  
folded size(LxWxH): 108x17x9cm  
net weight: 6kg  
Bearing: 159kg  
Material:aluminum alloy, oxford cloth  
Packing: 2pcs/carton  
Carton size: 110x20x22cm  
Gross weight: 13kg

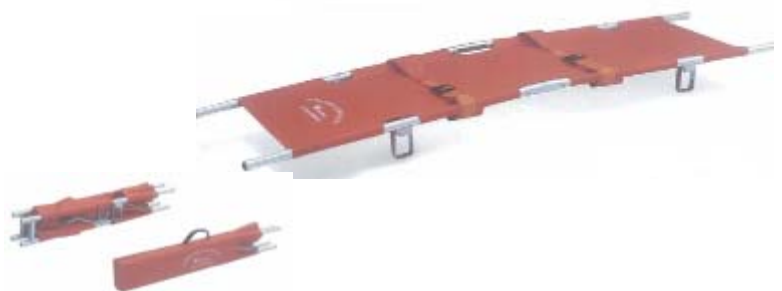

### **KHCKFAFS07**

Max unfolded size(LxWxH): 203x42x50x7cm

Min unfolded size(LxWxH): 167x42x7cm

net weight: 9kg

Bearing: 159kg

Material: aluminum alloy

Packing: 1pc/carton

Carton size: 170x41x7cm

Gross weight: 10kg

Usage:

Transfer fractured and serious patients

Can be separated into 2 part widthwise

Can put /release the patient into/off the stretcher without moving

Length Adjustable.

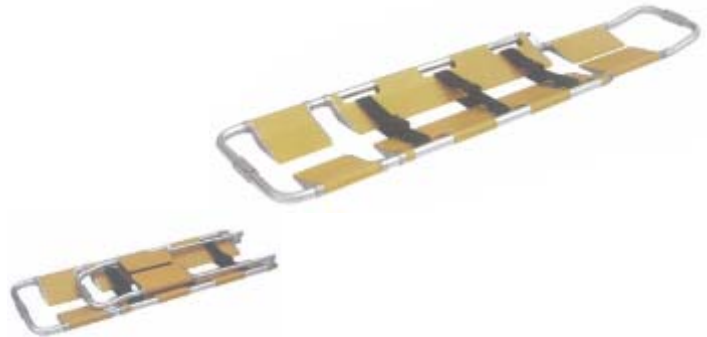

### **KHCKFAFS08**

Size(LxWxH): 184x45x5cm

Net weight: 6.5kg

Bearing: 159kg

Material: PE



## Oxygen Mask

### **KHCKFAOM01**

Oxygen mask

Material: PVC

Specs: L, M, S

Package: 100pcs/carton

Weight: 7.5kg/carton



### **KHCKFAOM02**

Oxygen mask with bag

Material: PVC

Specs: L, M

Package: 100pcs/carton

Weight: 7.5kg/carton



**KHCKFAOM03**

Breath machine  
Material: PVC/silica gel  
Package: 12pcs/carton  
Weight: 11kg/carton



**KHCKFAOM04**

Nebulizer Mask  
Material: PVC  
Specs: S, L, M  
Package: 100pcs/carton  
Weight: 8kg/carton



**KHCKFAOM05**

Disposable oxygen tube  
Material: PVC  
Specs: 200cm  
Package: 300pcs/carton  
Weight: 10kg/carton



**KHCKFAOM06**

Connection tube  
Material: PVC  
Specs: 200cm  
Package: 300pcs/carton  
Weight: 10kg/carton



**KHCKFAOM07**

Anesthesia Mask  
Material: PVC  
Specs: L, M, S  
Package: 100pcs/carton  
Weight: 7.1kg/carton



## Surgical Gown

### **KHCKPT01**

Soft and light

Water/oil/alcohol/blood proof.

Anti-static

Avoid cross infection

Material: wood pulp compound spunlace non-woven&SMS/SMMS&Spunlace

30gsm, 40gsm, 60gsm, 70gsm

Size S, M, L, XL, XXL



Woodpulp Spunlace Non-woven Material



Anti-water



SMS, or, SMMS

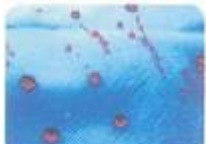

Anti-blood



Spunlace



Anti-oil

## Surgical Drape

### **KHCKPT02**

Good air breath ability

Water/oil/alcohol/blood proof.

Anti-static

Avoid cross infection

Material: SMS & wood pulp compound spunlace non-woven & paper & Poly

Size: 40x40, 60x60, 10801#, 10802#, 10803#, 120x140, 76x150



## Protective

### **KHCKPT03**

Soft and light weight

Comfortable cuts provides free movement

BFE more than 95%

Protective gown

Size: 170cm/175cm/180cm/185cm

Lab coat

Size: S, M, L

Visitor gown

Size: S, M, L



## Sleeves

### **KHCKPT04**

Waterproof, penetration resistant

Comfortable solid and durable

Material:

Non-woven sleeves 30gsm or 40gsm

Poly sleeves 0.02mm or 0.025mm

Size(cmxcn): 40x18, 45x22, 40x20, 42x22



## Bed sheet

### **KHCKPT05**

Water proof

Penetration resistant

Fits the mattress, soft and durable

Material: non-woven bed sheet

25gsm, 30gsm, 40gsm

Size(cmxcn): 80x150, 90x180, 150x210, 180x240

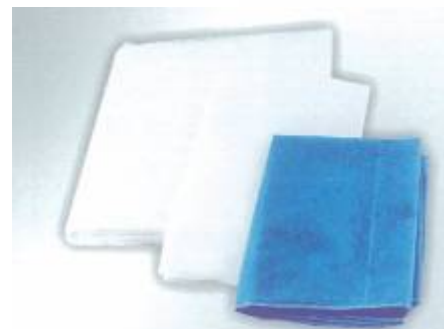

## Pillowcase

### **KHCKPT06**

Water proof

Penetration resistant

Soft and durable

Material:

25gsm, 30gsm, 40gsm

Size(cmxcn): 45x60, 45x70, 75x75



## Apron

### **KHCKPT07**

Water proof

Penetration resistant

Soft and durable

Material: non-woven 25gsm, 30gsm, 40gsm

Poly aprons 0.03mm

Size(cmxcn): 70x50, 110x95, 71x115, 80x130, 80x164

## Gloves

### **KHCKPT08**

Latex examination gloves(w/wo powder)

Elongation at break

Before aging Min 650%

After aging min 500%

Tensile strength

Before aging Min 18Mpa

After aging Min 14Mpa

Length Min 230mm

Width: Extra small $\leq$ 80mm, small  $80\pm 5$ mm, Medium  $95\pm 5$ mm, large  $100\pm 5$ mm, Extra large  $\geq 110$ mm

Thickness single wall

Palm 0.08mm min



### **KHTKPT09**

Latex surgeon gloves(w/wo powder)

Elongation at break

Before aging Min 750%  
 After aging min 560%  
 Tensile strength  
 Before aging Min 24Mpa  
 After aging Min 18Mpa  
 Length Min 280mm  
 Width: 6 1/2" 83±3mm, 7" 89±3mm, 7 1/2" 95±3mm, 8" 102±3mm, 8 1/2" 108±3mm, Thickness single wall  
 Palm 0.10mm min



**KHCKPT10**

PVC gloves(w/wo powder)  
 Technical Standard  
 Elongation≥350%  
 Tensile Stengh≥10MPa  
 latex-free  
 Pin Hole AQL 1.5 (1000ml water-leak test)  
 Ambidextous-fits either hand  
 Pre-powdered and powder-free available  
 Available in many colors  
 Beaded cuff



| Size | Length | Net Weight | Palm Width | Thickness |           |           |
|------|--------|------------|------------|-----------|-----------|-----------|
|      |        |            |            | Fingertip | Palm      | Cuff      |
| S    | 245±10 | 5±0.5      | 80±5       | 0.10±0.03 | 0.10±0.03 | 0.09±0.03 |
| M    | 245±10 | 6±0.5      | 95±5       | 0.10±0.03 | 0.10±0.03 | 0.09±0.03 |
| L    | 245±10 | 7±0.5      | 105±5      | 0.10±0.03 | 0.10±0.03 | 0.09±0.03 |
| XL   | 245±10 | 8±0.5      | 115±5      | 0.10±0.03 | 0.10±0.03 | 0.09±0.03 |

## Mask

### **KHCKPT11**

Mask Ultrasonic  
3 plies tie type (w/wo sterile)  
PP+anti-dust clothing  
20+20+30  
Total 70gsm



### **KHCKPT12**

2 plies tie type (w/wo sterile)  
PP  
20+30



### **KHCKPT13**

Mask Ultrasonic  
3 plies ear loop (w/wo sterile)  
PP+aut-dust clothing  
20+20+40



### **KHCKPT14**

2 plies ear loop (w/wo sterile)  
PP  
20+40



### **KHCKPT15**

Face mask with eye shield  
3 plies tie type  
PP+Anti-dust clothing+PP+PC  
20+20+40

### **KHCKPT16**

Active carbon mask  
4 plies ear loop  
PP  
20+35+20+30

## Shoes

### **KHCKPT17**

Shoes cover  
16cmx38cm PP40g  
16cmx36cm CPE2.5g



### **KHCKPT18**

Boots cover  
45cmx37cm PP40g



## Cap

### **KHCKPT19**

Cap  
Trip type  
Double elastic for nurse  
PP12g/14g



### **KHCKPT20**

Astronaut cap  
30cmx12.4cm  
PP40g



### **KHCKPT21**

Doctor cap  
53cm  
PP30g



### **KHCKPT22**

Nurse cap  
53cm  
PP30g



## Oxygen concentrator

### **KHCKOOC01**

Oxygen concentrator

Separate oxygen and nitrogen in the air by zeolite molecular sieve as a shift for medical usage

Oxygen density:  $\geq 90\%$

Oxygen flux: 1~5L/min

Output pressure: 0.04~0.05Mpa

Overrunning pressure alarm

Noise:  $\leq 55\text{dB(A)}$

Power supply: AC220 $\pm$ 22V, 50 $\pm$ 1HZ

Input power:  $\leq 600\text{VA}$



### **KHCKOOC02**

Oxygen concentrator(with nebulizing installation)

Separate oxygen and nitrogen in the air by zeolite molecular sieve as a shift for medical usage

Oxygen density:  $\geq 90\%$

Oxygen flux: 1~5L/min

Output pressure: 0.04~0.05Mpa

Overrunning pressure alarm

Noise:  $\leq 55\text{dB(A)}$

Power supply: AC220 $\pm$ 22V, 50 $\pm$ 1HZ

Input power:  $\leq 600\text{VA}$



### **KHCKOOC03**

Oxygen concentrator

Separate oxygen and nitrogen in the air by zeolite molecular sieve as a shift for medical usage

Oxygen density:  $\geq 90\%$

Oxygen flux: 1~3L/min

Output pressure: 0.04~0.05Mpa

Overrunning pressure alarm

Operation noise:  $\leq 49\text{dB(A)}$

Power supply: AC220 $\pm$ 20V, 50 $\pm$ 1HZ

Input power:  $\leq 350\text{VA}$



### **KHCKOOC04**

Oxygen concentrator(with nebulizing installation)

Separate oxygen and nitrogen in the air by zeolite molecular sieve as a shift for medical usage

Oxygen density:  $\geq 90\%$

Oxygen flux: 1~3L/min

Output pressure: 0.04~0.05Mpa

Overrunning pressure alarm

Operation noise:  $\leq 49\text{dB(A)}$

Power supply: AC220 $\pm$ 20V, 50 $\pm$ 1HZ

Input power:  $\leq 350\text{VA}$



## Anti- decubitus products

### **KHCKOAD01**

For the ones who lies on bed for long time to prevent bed sore. Or for the ones already with the tissue damage. It can reduce the pressure to skin.

Anti-decubitus mattress

Whole set: mattress+pump

There are 2 groups of pipes inside the mattress

The pump input air into one group and output from the other group. Shifts every 10 min.

.Material:

working condition: 240V $\pm$ 10% 50HZ $\pm$ 2%

Output power: 65W

Output pressure: 14kPa

Output flux: 7L/min

Bearing: 135kg

Size: 2000mmx900mmx110mm

Weight: 7.5-8kg

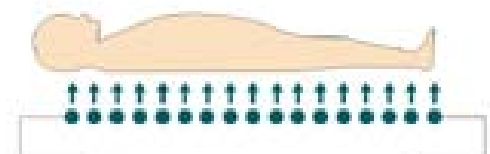
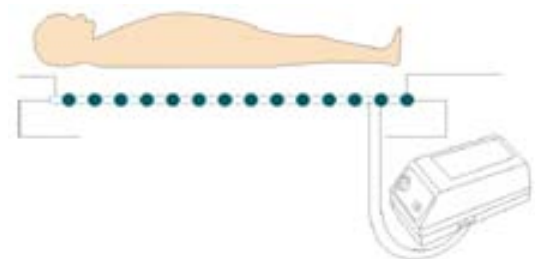

### **KHCKOAD02**

Anti-decubitus mattress (air-jet style)

There are tiny holes on the surface of the mattress.

There will be air jet from the mattress inside to decrease the humidity on bed.

It can replace foul air on the skin and control the growth of microbes

Material: rubber nylon sheet or PVC sheet

working condition: 240V±10% 50HZ±2%

Output power: 16W

Output pressure: 20kPa

Output flux: 14L/min

Bearing: 135kg

.Size: 2000mmx900mmx80mm

Weight: 6-6.5kg

### **KHCKOAD03**

Anti-decubitus seat (round)

Material: flocking

Bearing: 100kg

Size: 390mmx130mmx95mm



### **KHCKOPS01**

Portable phlegm suction unit:

Portable phlegm suction unit is a newly designed pump with free lubrication pump.

This unit is used to suck thick liquid, such as phlegm, blood, both for hospital use and home use.

Plastic square crust with the suction bottle inside.

Overflow protection design, preventing phlegm leaking into the machine.

Easy to take way

Voltage: AC220V± 10%, 50Hz±2%

Power: ≤90VA

Max negative pressure value: ≥0.075MPa

Pumping rate: 18L/min

Noise:≤ 65dB (A)

Reservoir volume: 1000mL, 1piece



### **KHCKOPS02**

suction for children

oil-free lubrication pump, with pressure dial. Easy to take.

Voltage: AC220V± 10%, 50Hz±2%

Power: 90VA

Max negative pressure value: ≥0.075MPa

Pumping rate: 15L/min

Noise:≤ 65dB (A)

## Medicine timer box

### **KHCKOMTB01**

Reservoir volume: 1000mL, 1piece

Medicine timer box (digital pill reminder timer box, medicine alarm container, pill alarm holder case)

Pill box timer with 8 group alarms setting per day

Two compartments to put the pills in

Large LCD display

Easy to use

bubble bag+white box

size: 10X6.4X1.6CM

Packing: 200PCS/CTN

Package size: 52\*37\*24cm

G.W./N.W.:13.8/12.8kgs



### **KHCKOMTB02**

medicine timer box (digital pill reminder timer box, medicine alarm container, pill alarm holder case)

Large four compartments for pills

Rotatable window for taking out pills

Display current time in 12 hours

8 group alarm clocks

Large & easy-read LCD

Keep reminding if the user don't press any button on the due time

Product Size: 100\*64\*22mm Battery: one AG10 battery 300pcs/ctn

carton dimension: 56\*33.5\*37cm



### **KHCKOMTB02**

Pills reminder

Large four compartments for pills/medicine.

The pills reminder with six large buttons for easy operation the medicine timer.

24 hours alarm clock remind to take the pills.

can set 4 group alarms per day as a reminder for medicine/pills.

4 group different alarm sound and easy-read LCD.

When the pill alarm time goes off, the different alarm sound and flashing symbol on LCD will remind a user of taking the pills from which compartment.

EL back light: the backlight is good useful at night

Product size:10.6x7.3x1.7cm

Packing: 120PCS/ctn

MEANS: 37.5\*34.5\*27CM



### **KHCKOMTB03**

Pill reminder. medicine timer box (digital pill reminder timer box, medicine alarm container, pill alarm holder case)

99 hours/59 minutes countdown;

Qty/size/ctn: 100pcs/32.5X30.5X20.5cm/ctn

Product size: 9.5x6.0x2.7cm

N.W/G.W: 5.2kg/ctn

### **KHCKOMTB04**

medicine timer box (digital pill reminder timer box, medicine alarm container, pill alarm holder case)

Flying plate-look

2. Pill Box Timer

3. The range of timing: Countdown within 24 hours

4. Power: AG13\*1(Button)battery

5. Size:83mm\*83mm\*30mm

Medication Reminder with Pill box

Key Features

24 hours countdown alarm function

2 Pill Compartments

Easy to program

Fits in pocket or purse

Easy to Read display

Operation instruction:

Key A is hour,

Key B is minute,

Key C is Start/pause.

At first,press A and B to set the time you want.

And press key C to begin to countdown (the digits on the LCD flash). If you press C for 2 second, the timer will pause (the digits on the LCD do not flash at this moment). If you press key C again, the timer will continue to

countdown the remained time.

When the set time is up, the timer will give out the alarm of beep-beep to remind the user. When the alarm is over, pressing key C will cause the timer to restart timing per the last setting.

Press Key A and B at the same time, the last setting is cancelled. The time can be reset.

If you can not set hours or minutes, please press key A and B at the same time to restart setting.

UNIT SIZE: 83\*83\*30MM

UNIT N.W.: 71G

MEAS: 47.5\*32\*46CM

Q'TY/CTN: 180PCS



G./N.W : 13.8/12.8KGS

### **KHCKOMTB05**

medicine timer box (digital pill reminder timer box, medicine alarm container, pill alarm holder case)

Medication Reminder with Pill box

Key Features

24 hours countdown alarm function

2 Pill Compartments

Easy to program

Fits in pocket or purse

Easy to Read display

operation instruction:

Key A is hour,

Key B is minute,

Key C is Start/pause.

At first,press A and B to set the time you want.

And press key C to begin to countdown (the digits on the LCD flash). If you press C for 2 second, the timer will pause (the digits on the LCD do not flash at this moment). If you press key C again, the timer will continue to countdown the remained time.

When the set time is up, the timer will give out the alarm of beep-beep to remind the user. When the alarm is over, pressing key C will cause the timer to restart timing per the last setting.

Press Key A and B at the same time, the last setting is cancelled. The time can be reset.

If you can not set hours or minutes, please press key A and B at the same time to restart setting.

Size:85\*51\*20mm

N.W.:50g

Package size:47.5\*32\*46cm

Qty: :330pcs/carton

G./N.W:16.8/16kgs



### **KHCKOMTB06**

medicine timer box (digital pill reminder timer box, medicine alarm container, pill alarm holder case)

Medication Reminder with Pill box Key Features

1. Capsule-look
2. Pill Box Timer
3. The range of timing: Countdown within 24 hours
4. Power: AG13\*1(Button)battery
5. Size: 86mm\*31mm\*31mm

operation instruction:

Key A is hour,

Key B is hunitite,

Key C is Start/pause.

At first,press A and B to set the time you want.

And press key C to begin to countdown (the digits on the LCD flash). If you press C for2 second, the timer will pause (the digitson the LCD do not flash at this moment). If you press key C again, the timer will continue to countdown the remained time.

When the set time is up, the timer will give out the alarm of beep-beep to remind the user. When the alarm is over, pressing key C will cause the timer to restart timing per the last satting.

Press Key A and B at the same time, the last setting is cancelled. The time can be reset.

If you can not set hours or minutes, please press key A and B at the same time to restart setting.

Size: 86\*31\*31MM

N.W.: 41G

Package size: 47.5\*32\*46CM

Qty: 280PCS/carton

G./N.W : 12.5/11.5KGS

## Toilet seat raiser

Toilet Seat Raiser is an elevated toilet seat designed for use by individuals with balance, mobility, or lower extremity disabilities

### **KHCKOTSR01**

Specs: without lock, without armrest

Material: PVC

Size: height 7", width 21", depth 17"

Package: 3pcs/ctn, ctn size: 500\*410\*425mm



### **KHCKOTSR02**

Specs: with locking without armrest

Material: PVC

Size: height 7",width 21",depth 17"

package:3pcs/ctn,ctn size:830\*535\*400mm



### **KHCKOTSR03**

Specs: with locking and with detachable armrest

Material: PVC

Size: height 7",width 21",depth 17"

Package: 3pcs/ctn,ctn size:625\*540\*480mm



## Hearing Aid

### **KHCKOHA01**

Behind the ear

Maximum saturation sound pressure level: 112db

Maximum acoustic gain: 38

Working voltage: 1.4v

Bottom battery: A675

Frequency: 300-3500hz



### **KHCKOHA02**

Body hearing aid

Maximum saturation sound pressure level: 133db

Maximum acoustic gain: 55db

Working voltage: 1.5v

Bottom battery: AA size

Frequency: 230-5000hz



### **KHCKOHA03**

in the canal (ITC)

Maximum saturation sound pressure level: 110db

Maximum acoustic gain: 24

Working voltage: 1.4v

Bottom battery: A312

Frequency: 200-3300hz



### **KHCKOHA04**

in the canal (ITC)

Maximum saturation sound pressure level: 115db

Maximum acoustic gain: 35

Working voltage: 1.4v

Bottom battery: A312

Frequency: 200-3300hz



### **KHCKOHA05**

Amplify sounds up to 50 decibels

Weights less than 35 grams

Personal volume control

Fit either ear



Operation Voltage: 1-2V

Current Drain: Max 42-45mA Min 40-43mA

T. H. D@1Khz: 3-6% Max Output THD@1Khz: 30-35% S/N Ratio: 45-50dB

Max Output Power: 10-20mW Frequency Response(-3db) Upper: 1-2KHz

Frequency Response(-3db) Lower: 240-300Hz Total Power Gain 48-50dB

Volume Hum Max 1. 5-2mV Min 0. 4-0. 8mV

Dummy Load 16Ω

### **KHCKOHA06**

Amplify sounds up to 40 decibels

Weights less than 10 grams

6 volume levels

Adjust to either ear

Operation Voltage: 1. 2-1. 6V

Current Drain: 6-8mA

T. H. D@1Khz: 1. 2-1. 6%

Max Output THD@1Khz: 2. 5-3%

S/N Ratio: 50-54dB

Max Output Power: 0. 7-0. 9mW

Frequency Response(-3db)

Upper: 3-4KHz

Frequency Response(-3db)

Lower: 300-400Hz

Dummy Load: 120Ω



### **KHCKOHA07**

Amplify sound up to 40 decibels

Intercept sounds from 15 metres away

Volume control for desired level of amplification

Use it and still go unnoticed

Extremely light weight&small size(2gms w/o battery)

Provide excellent stereo audio quality

MEAS: 37x37x20 CM Operation Voltage 1. 4-1. 6V

Current Drain Max 6. 3-8mA Min 6. 3-8mA

T. H. D@1Khz 1. 2-2% Max Output THD@1Khz 2-2. 5% S/N Ratio 55-58dB

Max Output Power 0. 075-0. 013mW Frequency Response(-3db)

Upper 3. 5-6. 5KHz Lower 400-700Hz

Volume Hum: Max 1. 0-1. 2mV Min 0. 2-0. 8mV

Dummy Load 120Ω



### **KHCKOHA08**

- Fully DSP-based multi-memory amplifier
- 10 bands gain adjust for fine tuning
- 2 channels WDRC compression
- Unique Dynamic Contrast Detection noise reduction technology
- Wideband output compression limiting (MPO)
- Adjustable feedback removal notch



| Technical Data            | KHCKOHA08-01 | KHCKOHA08-02 | KHCKOHA08-03 |
|---------------------------|--------------|--------------|--------------|
| Peak value                | 137+-3 dB    | 133+-3dB     | 133+-3dB     |
| Output at 1600 Hz         | 127+-3dB     | 123+-3dB     | 123+-3dB     |
| Maximum gain              | 65+-5dB      | 60+-5dB      | 60+-5dB      |
| Gain at 1600Hz            | 58+-5dB      | 55+-5dB      | 55+-5dB      |
| Battery current           | <=2mA        | <=1.5mA      | <=1.5mA      |
| Equivalent Input Noise    | <=30dB       | <=30dB       | <=30dB       |
| Total Harmonic Distortion | <=3%         | <=3%         | <=3%         |

### **KHCKOHA09-A**

- 100%digital
- Concealed programming socket
- Programmable Multi-Microphone Directional Processing
- On/off Switch built into Battery Door
- Programmable Telephone coil
- Multi-memory(1-4) push button with Tone Indicator
- Direct Audio Input (DAI) capability
- Numbered Volume Control
- Push on replaceable earhook
- 13#battery



### **KHCKOHA09-B**

- 100%digital
- Concealed programming socket
- Multi-memory(1-4) push button with Tone Indicator
- Direct Audio Input (DAI) capability
- Numbered Volume Control
- 13#battery



### **KHCKOHA10**

- Small size hybrid
- powerful output
- low current consumption

-Options:

- 1) Volume control with switch function
- 2) H-trimmer
- 3) L-trimmer
- 4) Gain trimmer
- 5) AGCO trimmer
- 6) Telecoil function

Peak value 115+-3dB 122+-3dB Output at 1600 Hz 112+-3dB 116+-3dB

Maximum gain 45+-5dB 50+-5dB Gain at 1600Hz 35+-5dB 40+-5dB

Battery current <=0.36mA <=1.0mA Equivalent Input Noise <=27dB <=27dB

Total Harmonic Distortion <=3% <=3%

**KHCKOHA11**

- Powerful push-pull output BTE
- Low frequency gain adjustment
- Overall output adjustment
- Telecoil input function
- Audio input function
- 675 # battery

| Technical Data            | KHCKOHA11-01 | KHCKOHA11-02 | KHCKOHA11-03 |
|---------------------------|--------------|--------------|--------------|
| Peak value                | 137+-3 dB    | 133+-3dB     | 133+-3dB     |
| Output at 1600 Hz         | 127+-3dB     | 123+-3dB     | 123+-3dB     |
| Maximum gain              | 65+-5dB      | 60+-5dB      | 60+-5dB      |
| Gain at 1600Hz            | 58+-5dB      | 55+-5dB      | 55+-5dB      |
| Battery current           | <=2mA        | <=1.5mA      | <=1.5mA      |
| Equivalent Input Noise    | <=30dB       | <=30dB       | <=30dB       |
| Total Harmonic Distortion | <=3%         | <=3%         | <=3%         |



**KHCKOHA12**

- Fully DSP-based multi-memory amplifier
- 10 bands gain adjust for fine tuning
- 2 channels WDRC compression
- Unique Dynamic Contrast Detection noise reduction technology
- Wideband output compression limiting (MPO)
- Adjustable feedback removal notch
- Digital trimmer and VC capable

| Technical Data    | KHCKOHA12-01 | KHCKOHA12-02 | KHCKOHA12-03 |
|-------------------|--------------|--------------|--------------|
| Peak value        | 113+-3dB     | 120+-3dB     | 125+-3dB     |
| Output at 1600 Hz | 108+-3dB     | 115+-3dB     | 119+-3dB     |
| Maximum gain      | 40+-5 dB     | 50+-5 dB     | 57+-5dB      |
| Gain at 1600Hz    | 35+-5 dB     | 40+-5 dB     | 50+-5dB      |
| Battery current   | <=1.0mA      | <=1.0mA      | <=1.5 mA     |



|                                     |             |             |
|-------------------------------------|-------------|-------------|
| Equivalent Input Noise $\leq$ 30dB  | $\leq$ 30dB | $\leq$ 30dB |
| Total Harmonic Distortion $\leq$ 3% | $\leq$ 3%   | $\leq$ 3%   |

## Cervical Vertebra Traction Device

### **KHCKOCVT01**

Traction power range: 0-60kPa  
Min5-10kPa  
Max 40-60kPa  
Middling: 10-40kPa  
Traction range: 1-15cm  
Size: 200x200x170mm  
Weight: 10.5-11.5kg  
Material:



### **KHCKOCVT02**

Traction power range: 0-30kPa  
Min5-10kPa  
Max 20-30kPa  
Middling: 10-20kPa  
Traction range: 1-20cm  
Size: 240x275x180mm  
Weight: 8.5-7.5kg  
Material:



### **KHCKOCVT03**

Traction power range: 0-20kPa  
Min5-10kPa  
Max 15-20kPa  
Middling: 10-15kPa  
Traction range: 1-18cm  
Size: 235x260x160mm  
Weight: 8.5-7.5kg  
Material:



## Massager

### **KHCKOM01**

- 1.The appearance is luxurious,fashionable and the streamline long handle design,has get the country patent.
2. The streamline is made from eraser material,non-silping and shocking,easy to take and operate.
- 3.Three work situation ,non-step speed adjustment, choice the function and speed freely.
4. Intelligent time controls combined with traditional heat therapy perfectly(3 minutes reach to 48°C),can adjust the eligible temperature ,massage together with heat therapy ,one massage two enjoys.
5. Attaches two sets changeable massage heads, different period, different effect



|         |              |
|---------|--------------|
| Size cm | 45×15×14.5   |
| Meas cm | 71.5×50.5×51 |
| Package | 12PCS        |
| G.W/CTN | 30kg         |

### **KHCKOM02**

Characteristics and functions:

- 1.The streamline long handle design, it is very easy to take and operate
- 2.Two ball shape massage heads give you more comfortable massage experience
- 3.3 kinds of the changeable heads you can chose from
- 4.Eases the fatigue caused by fierce sports and relaxes the muscle
- 5.Eases the pains caused by unsmooth circulation of breath and blood perennially
- 6.Eases the convulsion in the shoulder caused by stiff neck when sleeping
- 7.Eases the pains caused by fatigue or rheumatism
- 8.Burns fat and loses weight



|         |                |
|---------|----------------|
| Size)cm | 39.8×14.8×13.2 |
| Meas)cm | 61×46×44.5     |
| Package | 12PCS          |
| G.W/CTN | 18kg           |

**KHCKOM03**

Product introduction:

1. The fashionable appearance and the streamline handle shape design are popular with the customers
2. Through the improved massage double hump heads can massage more large area and strengthen massage effect
3. The more humanize design of the thin film switch fasten your operation. It adds the automatic program button, makes the massage more comfortable. four kinds of speed and five massage models can be chosen at will
4. You can enjoy the vibrate massage, far infrared ray and magnetic therapy synchronous



|         |               |
|---------|---------------|
| Size    | 38.3×9.5×11.5 |
| Meas    | 69×60×46      |
| Package | 25PCS         |
| G.W/CTN | 34kg          |

**KHCKOM04**

Features:

1. The streamline dolphin shape design, curve handle to prevent slide, easy massage every part of the body
2. You can enjoy the vibrate massage, far infrared and magnetic therapy synchronous
3. You can choose the three massage heads to make the massage more comfortable and useful



|         |                    |
|---------|--------------------|
| Size    | 38.5 x 10 x 13.2cm |
| Meas    | 69 x 44 x 57cm     |
| Package | 25PCS              |
| G.W/CTN | 34kg               |

## Condom

Latex Condom is made from latex and it is a main man contraceptive method . We could supply and export various kinds of condom , which could be described and divided by quality standard, width,figure style, color, lubricant, flavor, foil , packing, etc. .

| ITEM               | ISO4074:2002  | EN600:1996    | WHO:1998      |
|--------------------|---------------|---------------|---------------|
| Length             | ≥160mm AQL2.5 | ≥170mm AQL2.5 | ≥180mm QAL1.0 |
| Pinhole            | AQL0.25       | AQL 0.25      | AQL0.25       |
| Airbirst           |               |               |               |
| 1 volumn           | ≥16dm AQL1.0  | ≥18dm AQL1.0  | ≥18dm AQL 1.0 |
| 2 Pressure         | ≥1.0kPa       | ≥1.0kPa       | ≥1.0 kPa      |
| Tensile            |               |               |               |
| 1Force N           | ≥35N AQL2.5   | ≥39N AQL 1.0  |               |
| 2 Elongation%      | 650%AQL2.5    | ≥700% AQL1.0  |               |
| 3 Breaking Str Mpa | ≥17MPa AQL2.5 | ≥13MPa AQL1.0 |               |

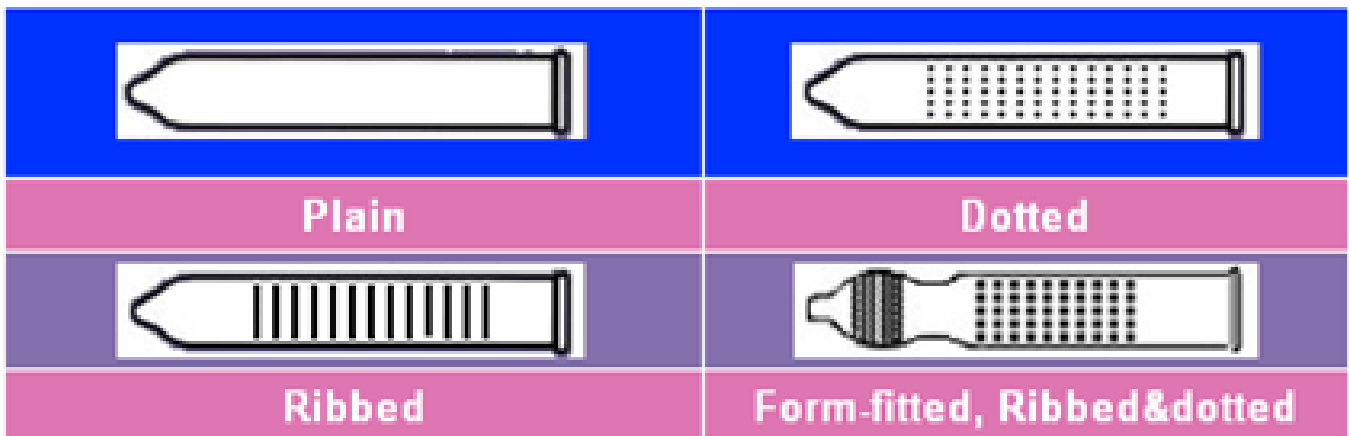

Width: 49MM/52MM/55MM

Length: ≥160mm/170mm/180mm

Color: neutral/pink/red/yellow/blue/green etc.

Flavor: banana/apple/strawberry etc

Lutricant: silicon oil/non-oxynol 9/No Lubricant